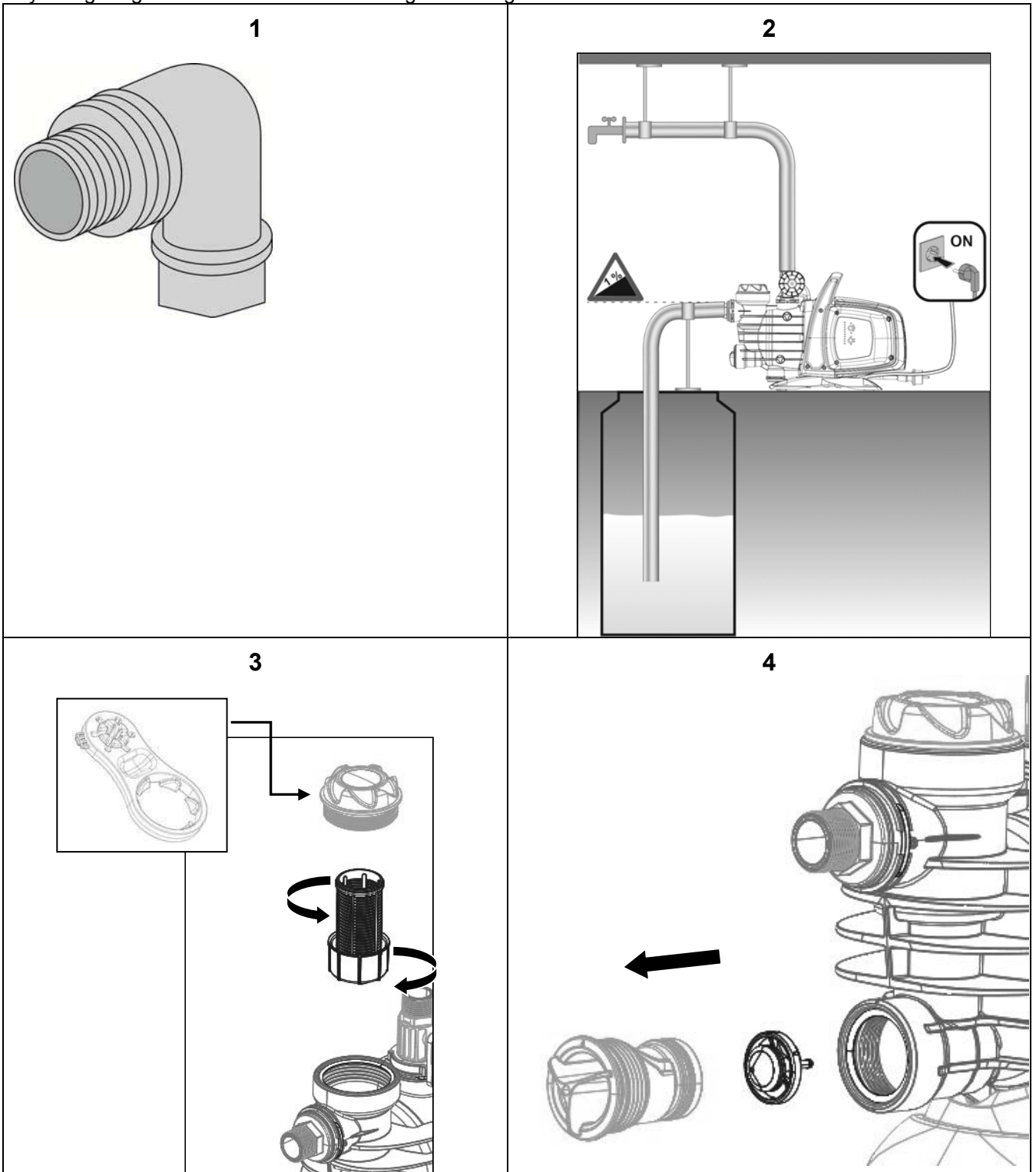

Fig - Fig. - Abb.- Fig.- Fig.- Фиг.- Obr.- Fig.- Еик. - Joonis - Kuva - Sl. - .ábra - Fig. - .att. - Afbeelding - Fig. - Rys.- Fig.- Fig. - Схема – Obrázok – Sl.- Fig. – Sl. - Fig. – Resim - Мал.



INDEX

1. APPLICATIONS	1
2. PUMPABLE LIQUIDS	2
3. TECHNICAL DATA AND LIMITATIONS OF USE	2
4. MANAGEMENT	2
4.1 Storage.....	2
4.2 Transport.....	2
4.3 Weight and dimensions.....	2
5. WARNINGS	3
6. INSTALLATION	3
7. ELECTRICAL CONNECTION	3
8. START-UP	3
9. ELECTRONIC CONTROL INTERFACE	4
9.1 Overview of the features.....	4
9.1.1 Description of the display:	4
9.2 Description of the functions	6
9.2.1 Pump ON/OFF (AUTO MODE, MANUAL MODE)	6
9.2.2 Priming phase.....	6
9.2.3 Alarms reset	6
9.2.4 Power ON/OFF indicator	6
9.2.5 Pump On/off indicator.....	6
9.2.6 Alarms indication	6
9.2.7 Dry running protection	6
9.2.8 ANTI-LEAKAGE	7
9.2.9 Max pump on.....	7
9.2.10 Pressure sensor alarm	7
9.3 First start up.....	7
9.3.1 Test on LEDs.....	7
9.3.2 First priming.....	7
9.4 Normal operations with CUT-OUT disabled (factory setting).....	7
9.5 Normal operations with CUT-OUT enabled.....	7
10. PRECAUTIONS	7
11. MAINTENANCE AND CLEANING	7
11.1 Cleaning the suction filter	8
11.2 Cleaning the NRV.....	8
12. TROUBLESHOOTING	8
13. GUARANTEE	9

WARNINGS



Read all this documentation carefully before installation:



Never touch the water when the pump plug is in the socket, even if the pump is not working. Take out the plug before any intervention. Absolutely avoid dry operation: the pump must be activated exclusively when it is immersed in water. If the water is finished, the pump must be deactivated immediately, taking the plug out of the socket.



Protect the electropump against inclement weather.



The pump is equipped with a thermal overload safety device. In the event of any overheating of the motor, this device automatically switches off the pump. The cooling time is roughly 15 to 20 minutes, then the pump automatically comes on again. If the overload cutout is tripped, it is essential to identify and deal with the cause of the overheating. See Troubleshooting.

1. APPLICATIONS

Self-priming centrifugal jet pumps with excellent suction capacity, even when gas is present in the water. Particularly indicated for water supply and pressure boosting in farmhouses. Suitable for small farming and gardening applications and for general hobby activity. Thanks to their compact and handy shape, they are also used for particular applications as portable pumps for emergency situations such as for drawing water from tanks or rivers.



These pumps cannot be used in swimming pools, ponds or basins where people are present, or for pumping hydrocarbons (petrol, diesel fuel, combustible oils, solvents, etc.) in accordance with the accident-prevention regulations in force. They should be cleaned before putting them away. See the chapter "Maintenance and Cleaning".

2. PUMPABLE LIQUIDS

Clean, free from solid bodies or abrasive substances, non-aggressive.

Fresh water	•
Rainwater (filtered)	•
Clear waste water	○
Dirty water	○
Fountain water (filtered)	•
River or lake water (filtered)	•
Drinking water	•

Table1

- Suitable
- Not suitable

3. TECHNICAL DATA AND LIMITATIONS OF USE

- **Supply voltage: 230V**, see electrical data plate
- **Delayed line fuses (230V version):** indicative values (Ampere)
- **Storage temperature:** -10°C +40°C

Model	Line fuses 230V 50Hz
P1= 850 W	4
P1= 1100 W	6

Table2

	Model	P1=850W	P1=1.100W
Electrical data	P1 Rated absorbed power [W]	850	1100
	P2 [W]	600	750
	Mains voltage [V]	1 ~ 230 AC	
	Mains frequency [Hz]	50	
	Current [A]	3.88	4.58
	Capacitor [µF]	12.5	16
	Capacitor [Vc]	450	
Hydraulic data	Max. flow rate [l/h]	3.180	3.750
	Max. head [m]	43	45
	Max. head [bar]	4.3	4.5
	Max. pressure [bar]	6	
	Max suction depth [m/min]	8 m / < 3min	
Range of use	Length of power cable [m]	1.5	
	Type of cable	H07 RNF	
	Grade of motor protection	IP X4	
	Insulation class	F	
	Liquid temperature range [°C] according to EN 60335-2-41 for domestic use	0 °C / +35 °C	
	Max. particle dimension [mm]	Clean water	
	Max. ambient temperature [°C]	+40 °C	
	Weight	DNM GAS	1" M
	Net/Gross weight approx. [kg]	9.6/11.8	10.3/12.5

Table 3



The pump cannot support the weight of the pipes, which must be supported in some other way.

4. MANAGEMENT

4.1 Storage

All the pumps must be stored in a dry covered place, with possible constant air humidity, free from vibrations and dust. They are supplied in their original pack in which they must remain until the time of installation.

4.2 Transport

Avoid subjecting the products to needless impacts and collisions.

4.3 Weight and dimensions

The adhesive plate on the packaging indicates the total weight of the pump and its dimensions.

5. WARNINGS



The pumps must never be carried, lifted or allowed to operate suspended from the power cable; use the handle provided.

- The pump must never be allowed to run when dry

6. INSTALLATION

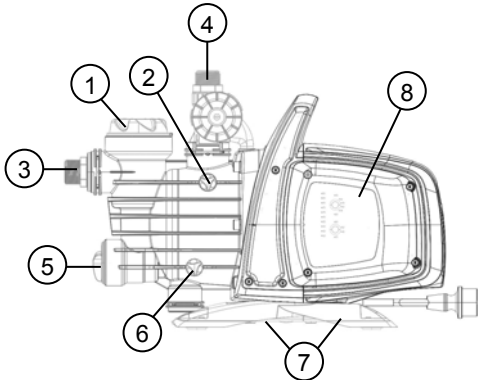

- 1 Pre-filter
- 2 Vent cap
- 3 Swivel suction connection
- 4 Delivery connection
- 5 Integrated non-return valve
- 6 Drainage cap
- 7 Vibration-damping rubber feet
- 8 Electronic control interface

The pump must be installed in a place protected from unfavourable weather conditions, and with an environment temperature not higher than 40°C.

The pump is provided with vibration-damping rubber feet, but in the case of fixed installations it is possible to remove them and provide anchorage to the base (7).

Do not allow the pipes to transmit excessive forces to the pump inlets (3) and (4), to avoid creating deformations or breakages.

It is always good practice to place the pump as close as possible to the liquid to be pumped. The pump must be installed only in horizontal position.

The pipes must never have an internal diameter smaller than that of the pump inlets; on intake, the pump is provided with a filter (1) and a non-return valve (NRV) (5).

For suction depths of over four metres or with long horizontal stretches it is advisable to use an intake hose with a diameter larger than that of the intake aperture of the pump. To prevent the formation of air pockets, the intake hose must slope slightly upwards towards the pump. Fig.2

If the suction pipe is made of rubber or flexible material, always check that it is of the reinforced vacuum-resistant type to avoid shrinkage due to suction.

In case of a fixed installation, it is recommended to fit a closing valve on both the suction side and the delivery side. This allows closure of the line upstream and/or downstream from the pump, useful for service and cleaning operations or for periods in which the pump is not in use.

The pump has a rotating inlet to facilitate installation (3) and (4)

In the case of flexible pipes, if necessary, use a bend fig. 1 and the gardening kit composed of a PE pipe and a kit of couplings with lance. These are not supplied, but can be bought separately. In the case of very small dirt, as well as the integrated filter (1), it is recommended to use a **pump inlet filter fitted on the suction pipe**.

- Do not subject the motor to excessive starts/hour; it is strongly recommended not to exceed 20 starts/hour.



The diameter of the suction pipe must be **greater than or the same as** the diameter of the pump inlet, see Table 3.

7. ELECTRICAL CONNECTION



Ensure that the mains voltage is the same as the value shown on the motor plate and that there is the possibility of making a good earth connection. **Follow the indications on the technical data plate and in this manual, table 3.**

The length of the power cable on the pump limits the installation distance, if an extension is required, make sure that it is of the same type (e.g. H05 RN-F or H07 RN-F depending on the installation) see tab.

8. START-UP



Do not start the pump without having completely filled it with liquid, about 4 litres, until it comes out of the air vent cap (2).

If the water supply is finished, take the plug out of the socket immediately and switch off the pump. Avoid dry running.

1. Before starting, check that the pump is properly primed, filling it completely, with clean water, through the filling hole, after having removed the filling cap of the transparent filter (1), with your hands or with the appropriate tool

ENGLISH

provided. At the same time open the vent cap (2) to let out the air. This ensures that the mechanical seal is well lubricated and that the pump immediately starts to work regularly. **Dry operation causes irreparable damage to the mechanical seal.**

2. The filling cap must be screwed on accurately until it stops (1), as must the vent cap (2).
3. Insert the plug of the power cable in a 230 V power socket. **Attention!** The pump motor will start immediately, the water will start to come out after a maximum time of 3 minutes, depending on the depth of the water level, in the well or cistern.
4. The pump will continue to work and supply water. Attention! Avoid dry running.
5. To switch off the pump, take the plug out of the power socket.

9. ELECTRONIC CONTROL INTERFACE

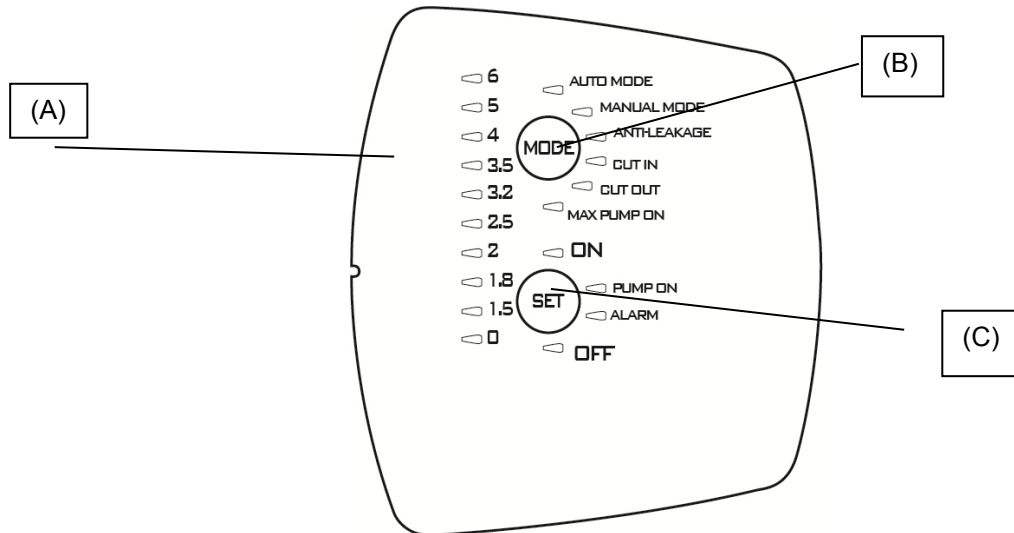

9.1 Overview of the features

Description	Parameters
Controller board voltage, frequency	1x230 V, 50/60 Hz
Power on/off indicator	●
Motor on/off indicator	●
Alarms indicator	●
Pressure indicator	●
Mode indicator	●
Auto Mode	●
Manual Mode	○
Dry-running protection	●
Anti-leakage	○
Max pump on protection	○ (30 minutes)
Cut-in pressure	○ Variable (1.5 – 3.0bar)
Cut-out pressure	○ (Cut-in + 1 bar)
Auto priming	●
Selection buttons	●

● = Fixed; ○ = Selectable



9.1.1 Description of the display:

(A) Pressure indicator LEDs

10 LEDs are used for indicating pressure from 0 to 6 bar. When the pressure in the system changes, the LEDs light up and switch off accordingly.

Function	Display configuration	Set	Alarm Reset
Auto Mode		ON: Enabled OFF: Disabled	

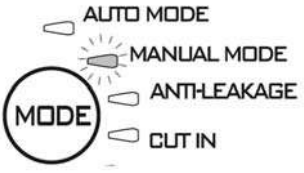
ENGLISH

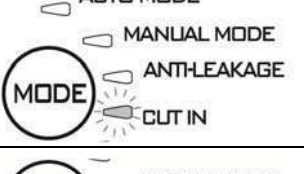
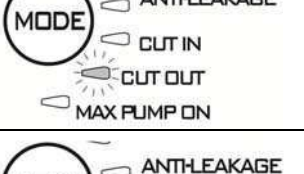
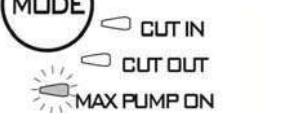
Manual mode		ON: Enabled OFF: Disabled	
Anti-leakage		ON: Enabled OFF: Disabled	Press SET
Cut in		Increase/Decrease	
Cut out		Increase/Decrease OFF: disabled	
Max pump on		ON: enabled OFF: disabled	Press SET

(B) MODE selection button

Selectable modes:

- 1) AUTO_MODE;
- 2) MANUAL_MODE;
- 3) ANTI LEAKAGE;
- 4) CUT_IN;
- 5) CUT_OUT,
- 6) MAX_PUMP_ON;

To unlock the choice of function press "MODE" button for 5 seconds.

Press "**MODE**" to scroll through the various operating modes (AUTO_MODE or MANUAL_MODE) or parameters to be modified (CUT IN and CUT OUT) or to enable certain functions (ANTI-LEAKAGE and MAX PUMP ON). While scrolling through the modes, the LED of the function selected will flash. On returning to AUTO_MODE the active functions will be highlighted by the relative LED lighting up with a steady light. See paragraph 2 (Description of the functions).

Indicators on "MODE"

AUTO MODE: the pump will work in automatic mode see 9.2.1

MANUAL MODE: the pump works in manual mode see 9.2.1, and the user can decide when to switch it on or off by acting on the "**SET**" button. SET-ON switched On SET-OFF switched Off.

CUT-IN: pressure setting (always enabled) minimum pressure below which the pump is activated, can be set between 1.5 and 3.0 bar, factory setting 1.8 bar; the pump is activated even if the flow is less than a minimum value of 1.5 l/min, factory-setting.

CUT-OUT: pressure setting (disabled) pressure above which the pump stops, the factory setting for "CUT-IN" + 1 Led, but can be increased to 6 bar.

To enable it select the function by pressing "MODE" until the LED corresponding to CUT-OUT flashes then press SET to select the required value, exit the setting by pressing "MODE". To disable the function, press "SET" until the light switches on to indicate OFF.

ANTI-LEAKAGE: protection against leakage. The function can be enabled or disabled: the factory setting is disabled. When enabled, if the condition is such that the pump is started up more than 6 times in 2 minutes, it will be stopped and the error will be indicated by means of the red LED flashing slowly on "**ALARM**".

To enable it select the function by pressing "MODE" until the LED flashes then press SET until the "ON" LED is switched on. To disable it press SET until the LED switches on to indicate OFF.

Once the cause is removed, reset the alarm, if still present, see 9.2.3.

MAX PUMP ON: maximum period of operation. The function can be enabled or disabled. The factory setting is disabled. When enabled, if the condition is such that the pump operates for more than 30 minutes, it will be stopped, no error indication is displayed.

ENGLISH

This function is used to protect the installation if a valve is left accidentally open, in the event of breakage of a pipe, or in applications for irrigation.

To enable it, select the function by pressing "MODE" until the LED corresponding to the MAX PUMP ON function is switched on, then press SET until the "ON" LED comes on. To disable it, press SET until the LED switches on to indicate OFF.

(C) SET selection button

Selectable modes:

- 1) Reset Alarms;
- 2) Enable/disable in MODE (MAX_PUMP_ON, ANTILEAKAGE)
- 3) Increases parameters in MODE (CUT_IN; CUT_OUT);
- 4) Motor ON/OFF in MANUAL MODE;
- 5) Pump active/pump in standby in AUTO MODE

Press "SET" to modify the parameters; if the LED is switched to MODE-CUT IN or MODE-CUT OUT, the value will be shown on the pressure indication LED bar. On pressing "SET" the value will increase. After setting the required value, exit the modification by pressing "MODE" and restore the LED to MODE-AUTO and SET "ON" enabled.

Press SET also to enable/disable the Anti-leakage and Max pump On functions. After selecting the function using the "MODE" button, enable it by selecting SET-ON, to disable it select SET-OFF.

In "MANUAL" mode, the SET is used to switch the pump on or off, LED "On" or "OFF".

In automatic mode AUTO-MODE it is used to turn it "ON" or in standby "OFF".

PUMP ON: indication that coincides with the motor running.

9.2 Description of the functions

9.2.1 Pump ON/OFF (AUTO MODE, MANUAL MODE)

Cut out disabled → on inserting the plug after the test on the LEDs the pump switches on for 10 seconds.

Cut out enabled → after the plug is inserted, the test is conducted on the LEDs for the first 3 sec (LED 0 indicates that the power is always On) and the "AUTO MODE" is set as default with the indicator "ON". The pump will start working if the pressure is less than the CUT -IN value and the flow is less than the minimum cut-in flow. The pump will continue to operate as long as the pressure remains less than the CUT-OUT value, and will switch off when this value is reached, independently of the flow.

While, if the "MANUAL MODE" is selected, by pressing once the "MODE", the pump will start up if the "ON" LED lights up, otherwise, if "SET" is pressed, the pump will switch itself off and the "OFF" LED will light up.

When the pump starts working, it will enter the PRIMING mode.

NOTE: Make sure the instructions for installation have been followed and that the pump is filled completely with water.

9.2.2 Priming phase

When the pump starts working, it will enter the priming mode, during this phase if there is no flow and pressure the motor will remain switched on for 3 minutes after which it will enter dry run alarm. But if flow and pressure are present during this phase, priming will be carried out and the pump will work normally.

9.2.3 Alarms reset

When there is an alarm, the red indicator on "ALARM" lights up. The alarm is reset by pressing "SET" once; if the cause of the alarm is eliminated, normal operation continues, otherwise the pump will return to alarm condition.

9.2.4 Power ON/OFF indicator

If power supply is present the pressure LED 0 on the LED bar lights up. If there is no power the LED remains switched off.

Note: for long shutdowns it is advisable to disconnect the plug from the power supply.

9.2.5 Pump On/off indicator

When the motor is running, a "PUMP ON" blue light must be On to indicate this status. When the motor stops, this LED switches off.

9.2.6 Alarms indication

A steady red light or button on "ALARM" is activated when an alarm is present.

Dry-running: steady red light

Leakage: slow pulse

Max Pump ON (pump running for more than 30 minutes): 2 quick flashes separated by a longer pause.

Press "SET" button to reset the alarms.

9.2.7 Dry running protection

If the pump is running dry, after a few seconds (40 sec.) it is stopped and an error indication appears with the steady red light on "ALARM".

After the initial 30 min when the pump is OFF a new restart attempt is made lasting 5 min. If this attempt is not successful, another attempt will be made every 30 min, up to a maximum of 48 times. If all these attempts fail, an attempt will be made every 24 hours.

The device automatically comes out of the Dry-running alarm status if the flow and/or pressure is restored.

ENGLISH

If the alarm is reset, see 9.2.3, a new attempt will be made after 40 sec.
Eliminate the causes and reset the alarm see 9.2.3.

9.2.8 ANTI-LEAKAGE

The function may be enabled or disabled. When enabled, if the condition is such that the pump is started up more than 6 times in 2 minutes, it will be stopped and the error will be indicated by means of the red LED flashing slowly on "**ALARM**".

Eliminate the causes and reset the alarm see 9.2.3.
For the enabling procedure see Anti-leakage

9.2.9 Max pump on

Maximum operating time. The function can be enabled or disabled. Factory setting is disabled. When enabled, if the condition is such that the pump works for more than 30 minutes, it will stop, and the ALARM light will flash. This function is used to protect the installation if the valve is accidentally left open, in case of breakage of a pipe, or in applications for irrigation.

9.2.10 Pressure sensor alarm

The pressure sensor alarm of the device is activated if the pressure value is outside the operating range (0-15 bar). The pump is switched off, the error will be reset as soon as the pressure conditions return within the range.

9.3 First start up

9.3.1 Test on LEDs

When the device is started up the first time, or after the plug is inserted in the power socket, the Test is conducted on the 20 LEDs, for a few seconds during which all the LEDs will light up in sequence.

9.3.2 First priming

The pump will automatically be in **AUTO** mode set to **ON**.

There may be three possible behaviours:

- 1) Flow present but low pressure: exits the priming phase and starts normal operation.
- 2) Pressure present but no flow: after 10 sec. in this condition the pump will switch itself off.
- 3) No flow no pressure: the pump will switch itself off and the Dry-running error will be displayed after about 3 minutes, indicated by the red LED in SET-ALARM. Eliminate the cause and reset the alarm see 9.2.3.

9.4 Normal operations with CUT-OUT disabled (factory setting)

Cut-out disabled means the following behaviour is present:

- The pump is activated if there is flow or pressure is absent, pressure is less than CUT IN (in 10 ms)
- The pump is stopped if the pressure is present but Flow is absent continuously for 10 s.

The CUT OUT LED will be switched off during normal operation. To modify the setting see 9.1.1.B

9.5 Normal operations with CUT-OUT enabled

Cut-out enabled means the following behaviour is present:

- The pump is activated if the pressure is less than the CUT IN pressure.
- The pump is stopped if the pressure is higher than the CUT OUT pressure.

The CUT OUT will be switched on during normal operation. To modify the setting see 9.1.1.B

10. PRECAUTIONS

RISK OF FROST: when the pump remains inactive at a temperature lower than 0°C, it is necessary to ensure that there is no water residue which could freeze, causing cracks in the plastic parts.

If the pump has been used with substances that tend to form a deposit, or with water containing chlorine, rinse it after use with a powerful jet of water in order to avoid the formation of deposits or encrustations which would reduce the characteristics of the pump.

11. MAINTENANCE AND CLEANING

In normal operation the pump does not require any type of maintenance. In any case, all repair and maintenance work must be carried out only after having disconnected the pump from the supply mains. When restarting the pump, ensure that it has been correctly reassembled, so as not to create a risk for persons and property.

11.1 Cleaning the suction filter

Fig.3

- Switch off the electric power supply to the pump.
- Drain the pump, opening the drainage cap (6), after having first closed the gate valves upstream (if present).
- Unscrew the cover of the filter chamber, with your hands or with the appropriate tool provided
- Extract the filter unit from the top
- Rinse the cup under running water and clean the filter with a soft brush.
- Reassemble the filter, performing the operations in inverse order.

11.2 Cleaning the NRV

(Fig.4)

- Switch off the electric power supply to the pump.
- Remove the cap of the NRV (5) with the accessory provided.
- Remove the NRV check valve and clean it to remove any dirt fig.9
- Assemble the parts, proceeding in inverse order to disassembly.

12. TROUBLESHOOTING



Before taking any troubleshooting action, disconnect the pump from the power supply (i.e. remove the plug from the socket). If there is any damage to the power cable or pump, any necessary repairs or replacements must be performed by the manufacturer or his authorized customer support service, or by an equally-qualified party, in order to prevent all risks.

FAULT	CHECKS (possible cause)	REMEDY
1. The motor does not start and makes no noise.	A. Check the electric connections. B. Check that the motor is live. C. Check the protection fuses. D. Possible intervention of thermal protection	C. If they are burnt-out, change them. D. Wait about 20 min until the motor cools. Check and eliminate the cause. N.B.: If the fault is repeated immediately this means that the motor is short circuiting.
1. The motor does not start but makes noise.	A. Ensure that the mains voltage is the same as the value on the plate. B. Look for possible blockages in the pump or motor. C. Check that the shaft is not blocked. D. Check the condition of the capacitor.	B. Remove the blockage C. Use the tool provided to release the shaft. D. Replace the capacitor
3. The motor turns with difficulty.	A. Check the voltage which may be insufficient. B. Check whether any moving parts are scraping against fixed parts.	B. Eliminate the cause of the scraping.
4. The pump does not deliver.	A. The pump has not been primed correctly. B. The diameter of the intake pipe is insufficient. C. NRV non-return valve or filter clogged.	A. Fill the pump with water and prime it, taking care to let air out by unscrewing the vent cap. B. Replace the pipe with one with a larger diameter. C. Clean the filter and, if this is not sufficient, the NRV.
5. The pump does not prime.	A. Suction pipe is taking in air.. B. The downward slope of the intake pipe favours the formation of air pockets.	A. Eliminate the phenomenon, checking that the connections and the suction pipe are airtight, and repeat the priming operation. B. Correct the inclination of the intake pipe.
6. The pump supplies insufficient flow.	A. The suction pipe is clogged. B. The impeller is worn or blocked. C. The diameter of the intake pipe is insufficient.	A. Clean the suction pipe.. B. Remove the obstructions or replace the worn parts. C. Replace the pipe with one with a larger diameter.
7. The pump vibrates and operates noisily.	A. Check that the pump and the pipes are firmly anchored. B. There is cavitation in the pump, that is the demand for water is higher than it is able to pump. C. The pump is running above its plate characteristics.	A. Fix the loose parts more carefully. B. Reduce the intake height or check for load losses. C. It may be useful to limit the flow at delivery.

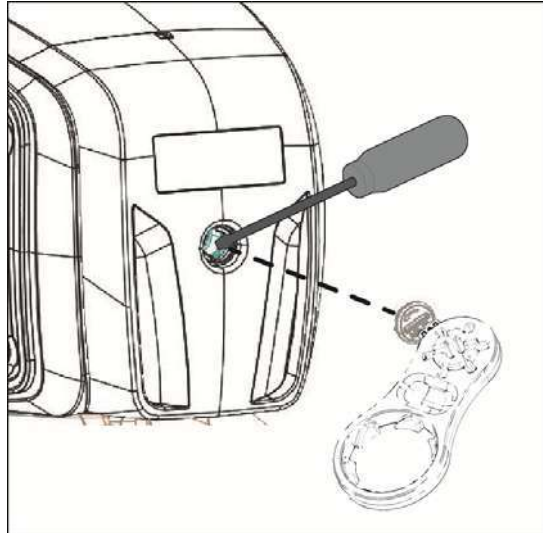

13. GUARANTEE



Any modification made without prior authorisation relieves the manufacturer of all responsibility. All the spare parts used in repairs must be authentic and all accessories must be authorised by the manufacturer, in order to ensure maximum safety of the machines and of the systems in which they may be installed.

This product is covered by a legal guarantee (in the European Community for 24 months from date of purchase) against all defects that can be assigned to manufacturing faults or to the material used.

The product under guarantee may, at discretion, either be replaced with one in perfect working order or replaced free of charge if the following conditions are observed:

- the product has been used correctly in compliance with the instructions and not attempt has been made to repair it by the buyer or by third parties.
- the product has been consigned to the outlet where it was purchased, attaching a document as proof of purchase (invoice or cash register receipt) and a brief description of the problem found.

The impeller and parts subject to wear are not covered by the guarantee. Intervention under guarantee does not extend the initial guarantee period in any way.